

VILA

REF. MU-VLA00

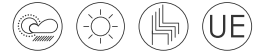

EMPRESA ASOCIADA
AIDIMME
INSTITUTO TECNOLÓGICO

UNE EN 581-1

UNE EN 581-2

Reg. Design: N° 4410330

Utility model: N° U201731460

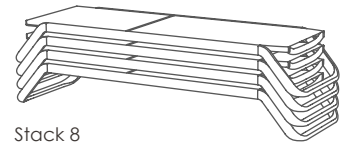
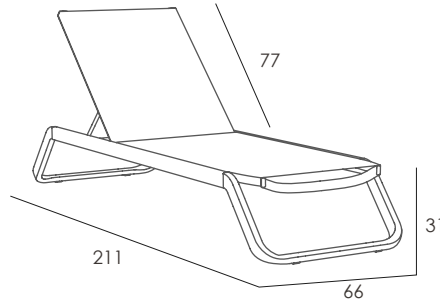

Stack 8

ES

Tumbona apilable. Estructura de aluminio lacado. Patas de polipropileno reforzado con fibra de vidrio. Tejido Phifertex®. Respaldo abatible 5 posiciones. Ruedas. Producto de uso público y doméstico. Usar en superficies estables y planas. Limpiar con agua jabonosa. Evite productos de limpieza agresivos.

PO

Espreguiçadeira empilhável. Estrutura alumínio lacado. Pés de polipropileno reforçado com fibra de vidro. Tecido Phifertex®. Encosto rebatível 5 posições. Rodas. Produto de uso público e doméstico. Use em superfícies estáveis e planas. Limpe com água e sabão. Evite produtos de limpeza agressivos.

EN

Stackable sunlounger. Lacquered aluminium structure. Legs in fiberglass reinforced polypropylene. Phifertex® fabric. Reclining backrest with 5 positions. Wheels. Public and domestic use product. Use on stable and flat surfaces. Clean with soapy water. Avoid aggressive cleaning products.

FR

Bain de soleil empilable. Structure aluminium laqué. Piètement en polypropylène renforcé avec fibre de verre. Toile Phifertex®. Dossier rabattable 5 positions. Roues. Produit à usage public et domestique. Utilisez sur des surfaces stables et plates. Nettoyer avec de l'eau savonneuse. Évitez les produits de nettoyage agressifs.

DETALLES / DETALHES / DETAILS / DÉTAILS

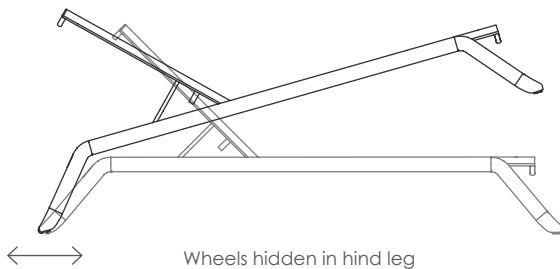

Wheels hidden in hind leg

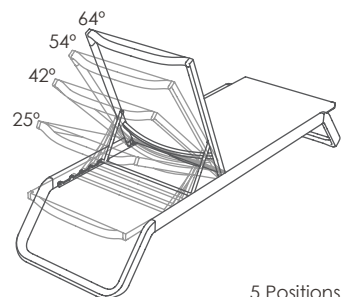
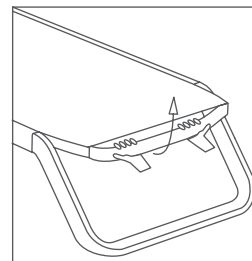

5 Positions

ACABADOS / ACABAMENTOS / FINISHES / FINITIONS

PHIFERTEX
Outdoor Fabrics

010T11

020T11

091T11

White

Taupe

Anthracite

DATOS LOGÍSTICOS / DADOS LOGÍSTICOS / LOGISTIC DATA / DONNÉES LOGISTIQUES

	Kg un.	CBM m3/un	Un. / Medidas Pallet	Peso Pallet	Un. / Medidas Caja	Cant. Camión	Cant. Contenedor 40"	Cant. Contenedor 20"
Montada	11,4 Kg	0,18	20 un. 212x75x220 cm	243 Kg	1 un. 214x75x223 cm	380 un.	320 un.	160 un.
Montada par	11,5 Kg	0,3	12 un. 212x75x220 cm	153 Kg	2 un. 214x75x213 cm	192 un.	153 un.	-
Desmontada	11,5 Kg	0,2	16 un. 212x75x220 cm	199 Kg	4 un. 2 caj 214x75x231 cm	256 un.	199 un.	-

Made in Portugal

VILA ARMS

REF. MU-VLA01

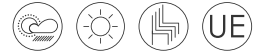

EMPRESA ASOCIADA
AIDIMME
INSTITUTO TECNOLÓGICO

UNE EN 581-1
UNE EN 581-2
Reg. Design: N° 4410330
Utility model: N° U201731460

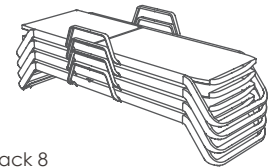
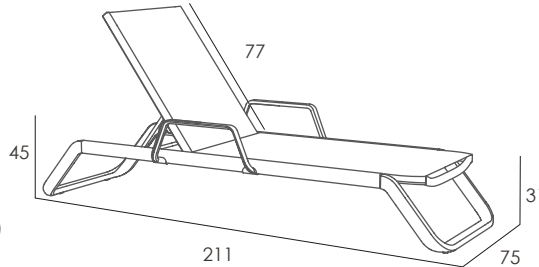

ES

Tumbona apilable con brazos. Estructura de aluminio lacado. Patas de polipropileno reforzado con fibra de vidrio. Tejido Phifertex®. Respaldo abatible 5 posiciones. Ruedas. Producto de uso público y doméstico. Usar en superficies estables y planas. Limpiar con agua jabonosa. Evite productos de limpieza agresivos.

PO

Espreguiçadeira empilhável com braços. Estrutura alumínio lacado. Pés de polipropileno reforçado com fibra de vidro. Tecido Phifertex®. Encosto rebatível 5 posições. Rodas. Produto de uso público e doméstico. Use em superfícies estáveis e planas. Limpe com água e sabão. Evite produtos de limpeza agressivos.

EN

Stackable sunlounger with arms. Lacquered aluminium structure. Legs in fiberglass reinforced polypropylene. Phifertex® fabric. Reclining backrest with 5 positions. Wheels. Public and domestic use product. Use on stable and flat surfaces. Clean with soapy water. Avoid aggressive cleaning products.

FR

Bain de soleil empilable avec accoudoirs. Structure aluminium laqué. Piètement en polypropylène renforcé avec fibre de verre. Toile Phifertex®. Dossier rabattable 5 positions. Roues. Produit à usage public et domestique. Utilisez sur des surfaces stables et plates. Nettoyer avec de l'eau savonneuse. Évitez les produits de nettoyage agressifs.

DETALLES / DETALHES / DETAILS / DÉTAILS

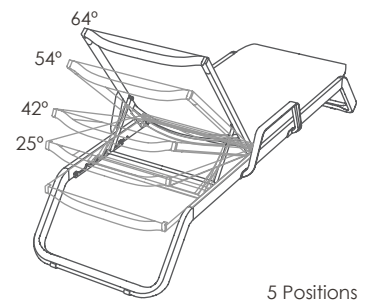
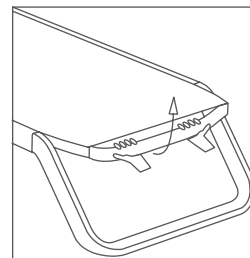
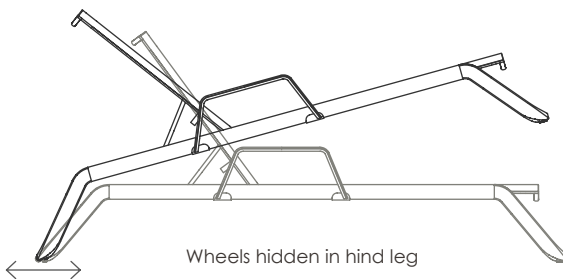

ACABADOS / ACABAMENTOS / FINISHES / FINITIONS

PHIFERTEX
Outdoor Fabrics

010T11	020T11	091T11
White	Taupe	Anthracite

DATOS LOGÍSTICOS / DADOS LOGÍSTICOS / LOGISTIC DATA / DONNÉES LOGISTIQUES

	Kg un.	CBM m3/un	Un. / Medidas Pallet	Peso Pallet	Un. / Medidas Caja	Cant. Camión	Cant. Contenedor 40"	Cant. Contenedor 20"
Montada	11,4 Kg	0,18	20 un. 212x75x220 cm	243 Kg	1 un. 214x75x223 cm	380 un.	320 un.	160 un.
Montada par	11,5 Kg	0,3	12 un. 212x75x220 cm	153 Kg	2 un. 214x75x213 cm	192 un.	153 un.	-
Desmontada	11,5 Kg	0,2	16 un. 212x75x220 cm	199 Kg	4 un. 2 caj 214x75x231 cm	256 un.	199 un.	-

Made in Portugal

VILA

Tops: 45 x 45 cm

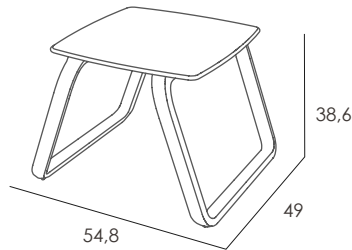

ES

Mesa auxiliar apilable. Patas de polipropileno reforzado con fibra de vidrio. Tablero compacto. Desmontable. Válida para uso exterior. Producto de uso público. Usar en superficies estables y planas. Limpiar con un paño húmedo con agua jabonosa. Evitar productos de limpieza agresivos.

PO

Mesa auxiliar empilhável. Pés de polipropileno reforçado com fibra de vidro. Tampo compacto. Desmontável. Uso ao ar livre. Produto de uso público. Use em superfícies estáveis e planas. Limpe com pano úmido com água e sabão. Evite produtos de limpeza agressivos.

EN

Stackable side table. Legs in fiberglass reinforced polypropylene. Compact table top. Detachable. Suitable for outdoor use. Public use product. Use on stable and flat surfaces. Clean with damp cloth with soapy water. avoid aggressive cleaning products.

FR

Table auxiliaire empilable. Piètement en polypropylène renforcé avec fibre de verre. Plateaux compact. Démontable. Pour l'extérieur. Produit à usage public. Utilisez sur des surfaces stables et plates. Nettoyer avec un chiffon humide et de l'eau savonneuse. éviter les produits de nettoyage agressifs.

DETALLES / DETALHES / DETAILS / DÉTAILS

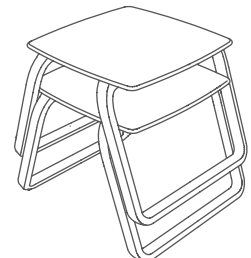

ACABADOS / ACABAMENTOS / FINISHES / FINITIONS

(Heat-laminated compact table top. Thickness 10mm)

COMPACT

MAK-VLAC04505	MAK-VLAC04506	MAK-VLAC04507
White	Taupe	Anthracite

DATOS LOGÍSTICOS / DADOS LOGÍSTICOS / LOGISTIC DATA / DONNÉES LOGISTIQUES

Kg un.	CBM m3/un	Un. / Medidas Pallet	Peso Pallet	Un. / Medidas Caja	Cant. Camión	Cant. Contenedor
5,5 Kg	0,01	60 un. 120x80x205 cm	345 Kg	1 un. 47x50x15 cm	- un.	- un.

Made in Portugal